

OMEGA COMPRESSORS

For us, it's not just business. It's personal.

CC-DX-0560

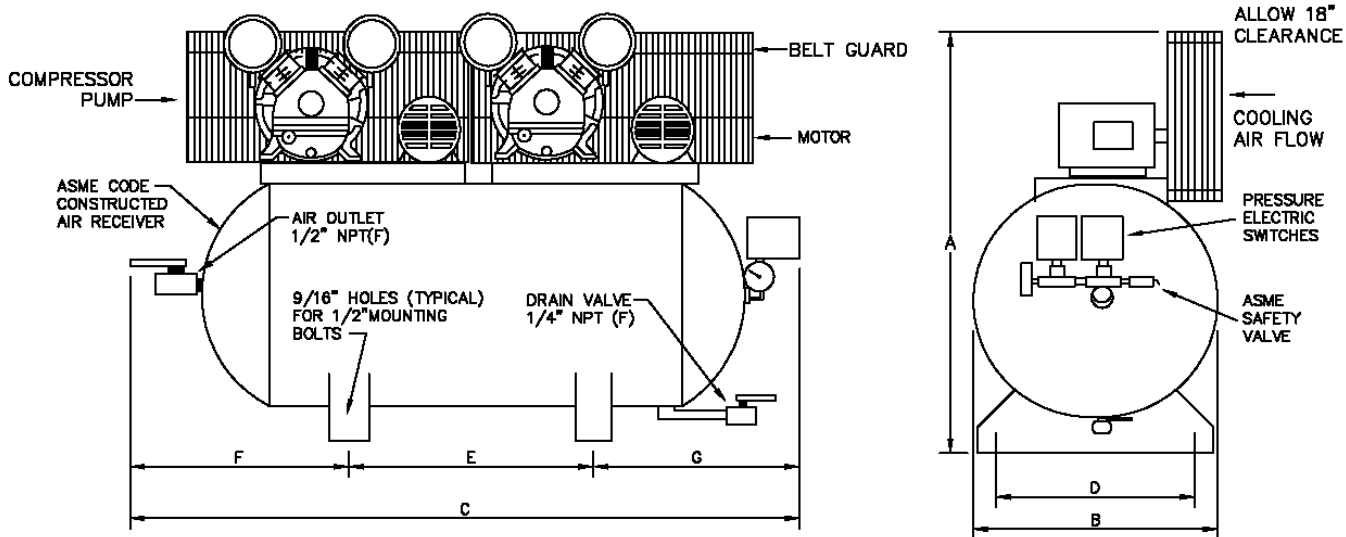

PERFORMANCE DATA

MODEL	HP	DELIVERY		PRESSURE SETTINGS		RECEIVER		COMPRESSOR			
		SCFM	L/S	PSIG	KPA	Gal	US. LITERS	PUMP	RPM	CYL	STGS
CC-DX-0560	.5	2.4	1.13	70-90	480-620	60	227	PK-50	509	V-2	1

DIMENSIONAL DATA (inches)

MODEL	A	B	C	D	E	F	G
CC-DX-0560	40	21	61	18.75	24	19	18

WT. DISTRIBUTION (Lbs)

FT.1	FT.2	FT.3	FT.4	TOTAL
87	130	92	118	427

ELECTRICAL DATA (60Hz)

HP.	APPROX. FULL LOAD AMPS					
	Single Phase		Three Phase			
	110V.	220V.	200V.	230V.	460V.	575V.
.5	8.0	4.0	2.2	2.0	1.0	0.8

BELT GUARD SIDE	
2	4
1	3

OMEGA AIR COMPRESSORS	HVAC SERIES	1/2 HP TANK MOUNTED DUPLEX COMPRESSOR	Print No: Dwg: Chk'd	ESJL33S-1 Scale: Not to. Wt Dist: +-5lbs
Typical only. Data & specifications may be subject to change. May not include accessory items for any particular order.			Project Reference:	